



TUSK
LIVING

LA FAMIGLIA
WOODFIRE PIZZA OVEN KIT

ASSEMBLY INSTRUCTIONS



CONTENTS

HEALTH AND SAFETY	3
WHAT YOU NEED	3
BEFORE YOU START	3
BASE DETAILS	4
CONSTRUCTION	4-12
TROUBLESHOOTING	13



HEALTH AND SAFETY

We recommend that before you commence building your oven that you take a few precautions to avoid injury. The oven chambers are heavy and will need assistance when lifting into position.

The following items are highly recommended to be worn during construction:

- Protective footwear
- Safety glasses
- Breathing mask
- Protective gloves

WHAT YOU NEED: NOT INCLUDED IN THE KIT

- Kitchen tin-foil, measuring tape, sponge, tin snips, sharp knife, trowel, spirit level, and a float for rendering
- 5 x 20kg buckets of sand
- 1 x 20kg Lite or White Cement Premix containing lime (if no premix add 5kg of Lime)
- Add 800mL to 1L of 'Bondcrete'
- Add 800mL of "Lanco" Cement Accelerator
- OPTIONAL: 1 x 20kg bag of Crushed Granite 2-7mL (this is for a rough texture)
- Rollers or Crowbar for assistance in placing chambers

BEFORE YOU START: ALLOW 5 HOURS FOR CONSTRUCTION

Keep all oven parts dry before rendering. We suggest you use a mask, safety glasses and gloves when handling the insulation blanket and the mortar powder. These products may cause irritation to eyes and skin (see note).

Read through the instructions completely before you start, and keep the instructions handy during the construction process. Before you begin, familiarise yourself with the installation steps and have everything ready.

Note: The insulation is a natural wool product, which is fully soluble and non-toxic, though contact with skin may cause irritation. A material safety data sheet is available on request.

BASE DETAILS

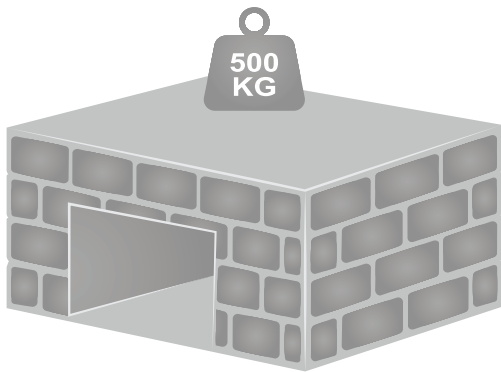

The expected size of a completed medium oven is 1,300mm long by 900mm wide. We recommend constructing a base of about 1400-1500mm long by 1200mm wide as a minimum and able to support an oven weight of 500kg.

A work surface around the oven (for pizza boards, roasting trays etc.) is also advantageous. The concrete slab (top of base) must be dry, level and clean before commencing oven construction. A concrete sealant is recommended to prevent the oven drawing moisture from the base.

STEP ONE

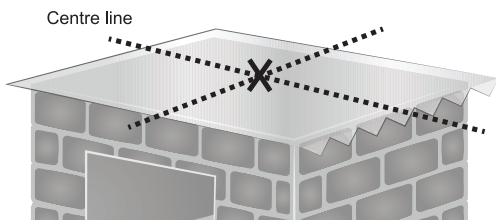

Completely cover the base in tin foil and mark the center of the oven on the base.

Note: Foil at the bottom is a great heat reflector and also acts as an extra moisture barrier. The foil reflects heat back into the chamber and assists in the cooking process.

STEP TWO

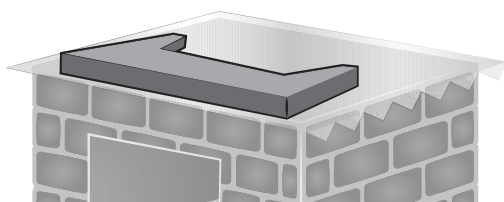

Find the center line of the front floor slab (approx. 362mm), and then place on the marked center line of the oven base.

STEP THREE

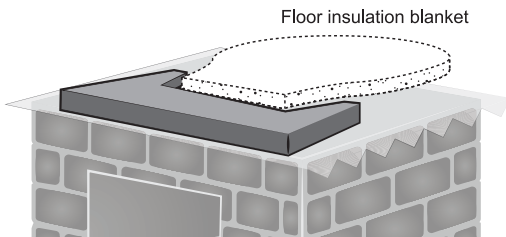

Install the oven floor insulation blanket and flatten down tightly.

Note: The insulation blanket will settle and flatten over time from the weight of the tiles and after a few fires.

Tip: To prepare, it is helpful to get a large piece of ply wood and squash the insulation blanket down before beginning. However, this is not essential.

STEP FOUR

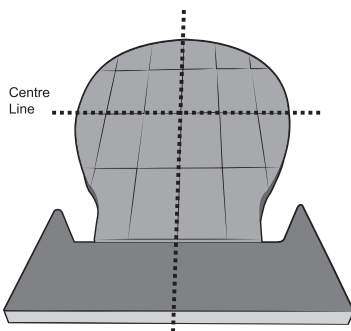
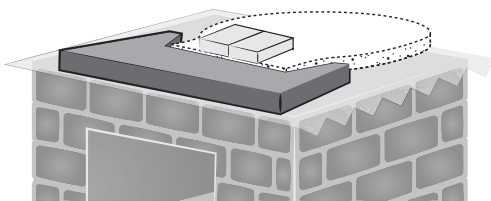

Install floor tiles, starting by placing one tile to the right of the floor slab center line and one tile to the left of the floor slab center line.

Note: It is important to fit the tiles as best as possible. If the tiles are “too small” and leave gaps between them and the chamber, this is not an issue as ash will fill these gaps and stiffen the base after a few fires.

If the tiles are “too big/ tight” to fit in the chambers, some trimming may be required.

STEP FIVE

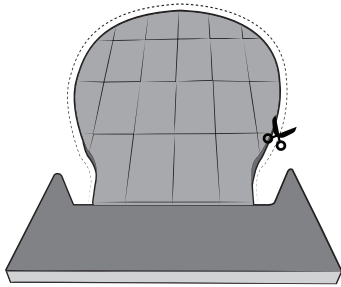

Install the numbered floor tiles. Trim insulation as tight to the tiles as possible.

Note: You may have gaps between tiles. Ash from the fire will fill any gaps and help stiffen the base.

STEP SIX

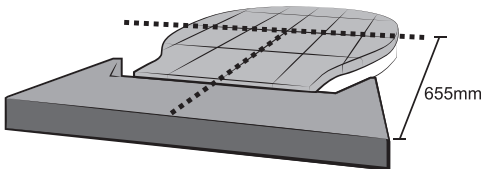

Measure back from front floor piece 655mm. Mark on the foil both sides of the base.

STEP SEVEN

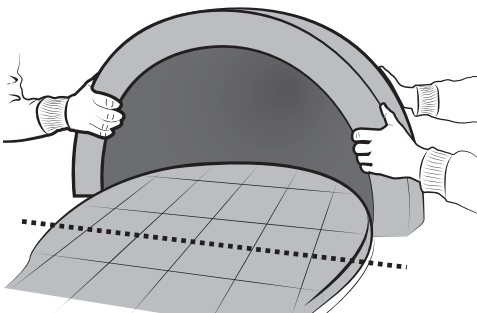

Install rear chamber to marked lines.

STEP EIGHT

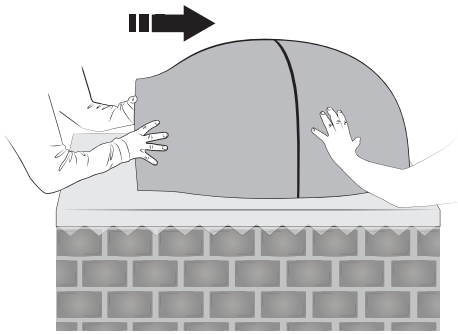

Remove the front floor slab before placing the middle chamber. Put the middle chamber up against the rear chamber.

Note: Ensure the chambers align on the inside of the oven. The chambers do not need to align perfectly on the outside as external joints will be covered by cement, insulation and render in the following steps.

STEP NINE

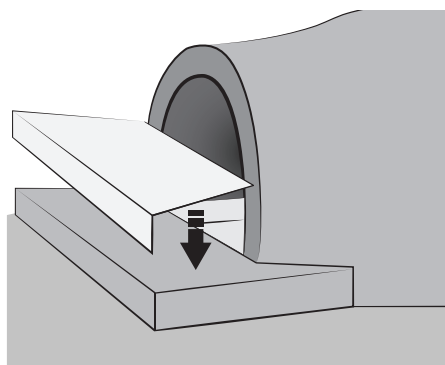
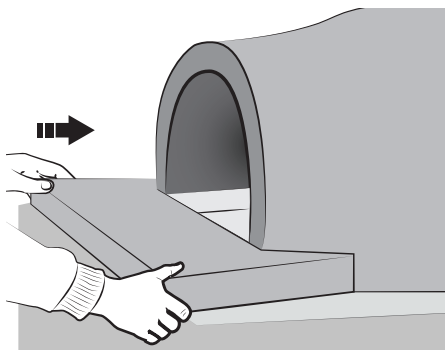

Place the front floor slab in front of the middle chamber and place the metal tray on top.

STEP TEN

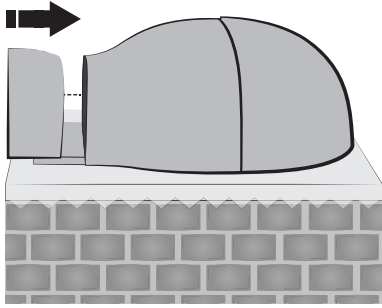

Place the front chamber on top of the front floor slab and as close to the middle chamber.

Note: Ensure the chambers align on the inside of the oven. The chambers do not need to align perfectly on the outside as external joints will be covered by cement, insulation and render in the following steps.

STEP ELEVEN

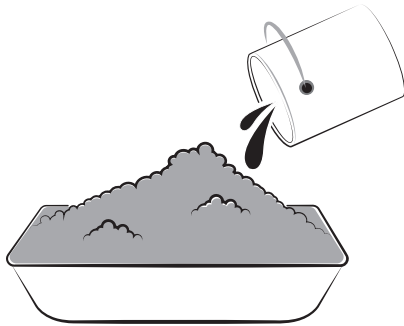

Mix the bonding cement supplied in green bag. This will be used to seal all external joints using a trowel and sponge.

STEP TWELVE

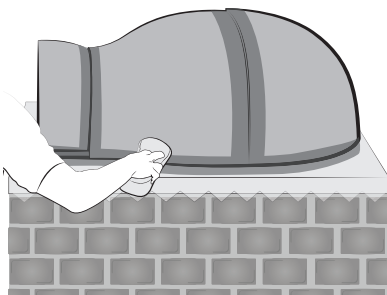

Wet down the areas that are to be joined with a sponge.

STEP THIRTEEN

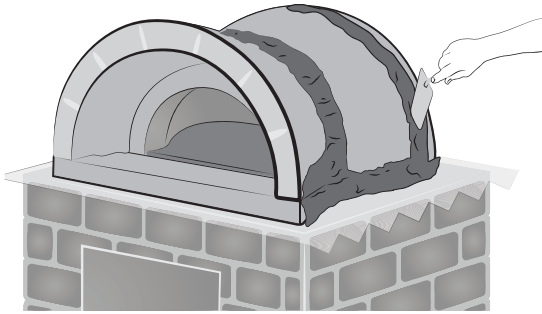

Using your trowel, place strips of bonding cement around the base of the oven and in between the external joints of the three chambers.

Tip: Excess bonding cement can be kept for maintenance.

STEP FOURTEEN

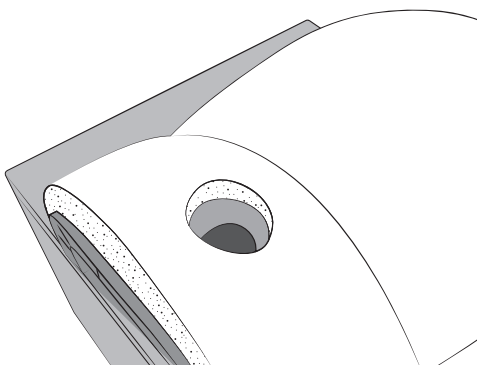
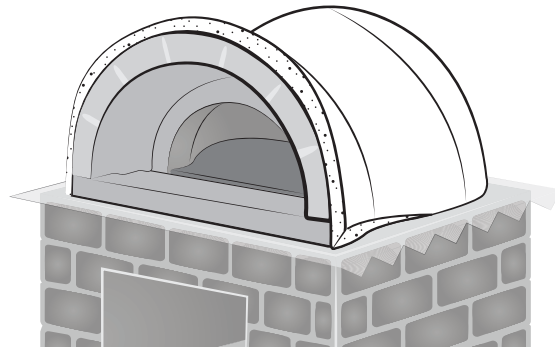
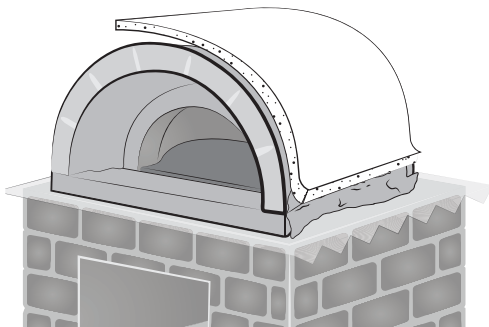

Wrap remaining insulation blanket around the entire oven chamber. Excess must be cut away.

Start at the front, finish at the back ensuring complete coverage. Excess insulation must be used to plug gaps. Cut a hole for the flue.

STEP FIFTEEN

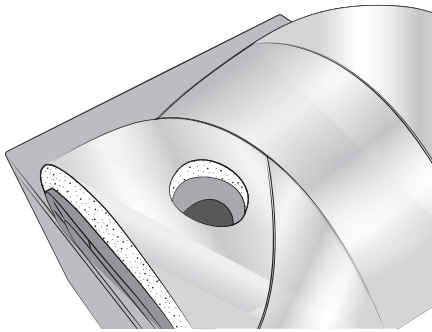
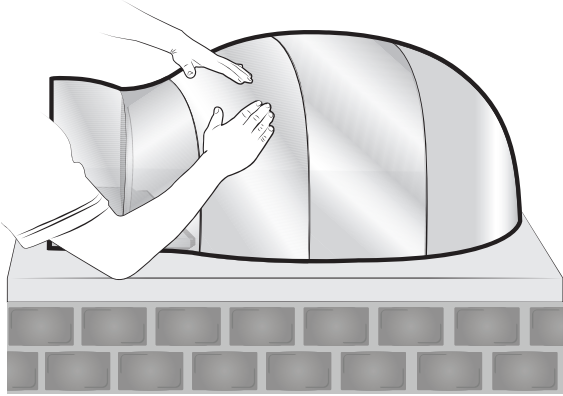

Wrap the oven in aluminum foil. Masking tape may be used to hold aluminum foil in place. Cut a hole for the flue.

STEP SIXTEEN

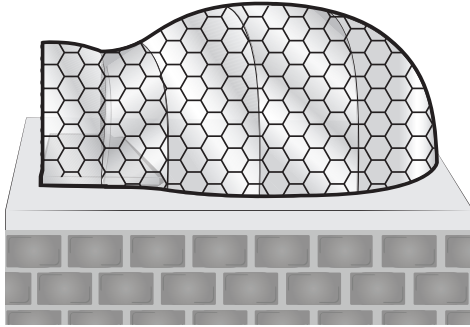

Wrap the oven in chicken wire. This will enable the render to adhere to the oven. Excess must be cut away.

STEP SEVENTEEN

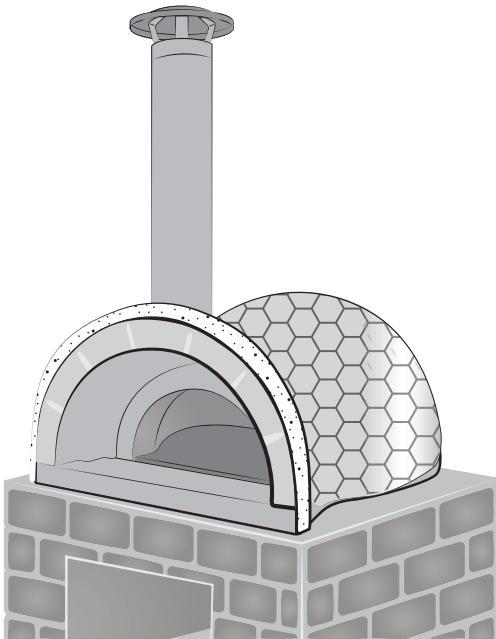

Insert the flue into the front chamber hole with the seam of the flue facing the back of the oven before beginning the rendering process. Use a spirit level to ensure the flue remains straight.

STEP EIGHTEEN

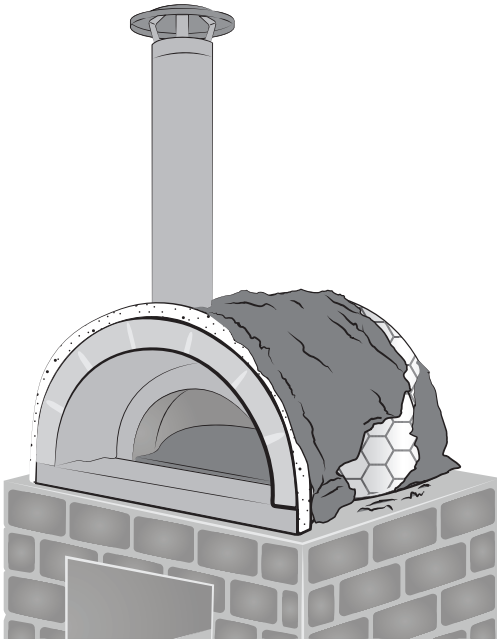

The oven is now ready for render. Please note that this oven is fully insulated. The finishing render is cosmetic and acts to keep out moisture. A thick layer is not required.

Render mix quantities required for each oven is variable, and is dependent upon the ultimate shape and finish desired. As a guide however, the following basic render mix should provide complete coverage if applied as a 15-20mm layer:

- 5 x 2kg sand
- 1 x 20kg bag of cement (light cement if you can get it)
- 5kg of lime
- 800mL of Bondcrete to be added to final mix
- Optional: 1 x 20kg bag Granite (crushed)

Note: Large entertainer kits will require 2 x extra bags of sand and 10kg of cement.

Oxides can be added for colour. A completed oven can be painted any colour (e.g. terracotta, or sandstone) when finally cured. The front arch and floor piece may also be painted (e.g. black).

Smooth render with a sponge.

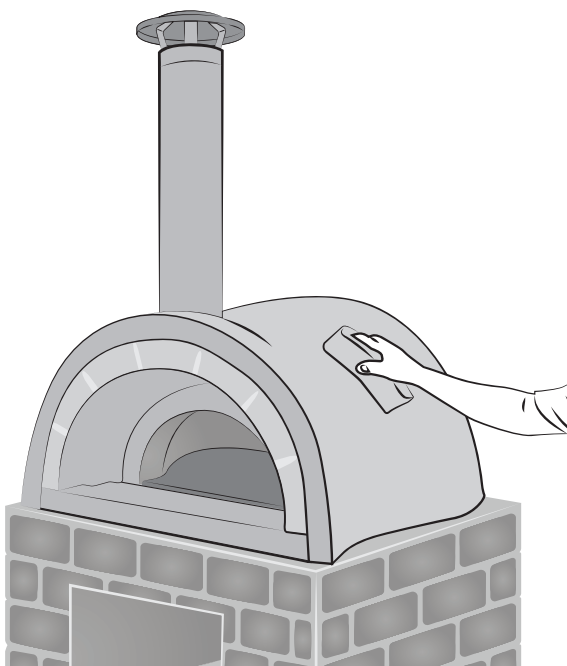



TROUBLE-SHOOTING

Water/moisture will damage and seriously affect the efficiency of the oven (i.e. the oven won't quickly reach full operating temperature when lit), so keep the oven dry until it is rendered and sealed.

'Cure' the oven (to remove moisture) by first allowing the oven to dry naturally for a few days, and by then lighting a small fire. Keep the fire lit for as long as possible everyday until cured. A cured oven will emit very little smoke, and the black carbon (which will initially appear inside the chambers) will disappear (the inside chambers turning white). However, small hairline cracking can appear due to the intense heat of a wood fire - particularly if an oven is not cured properly. This is normal, and no problems generally result; however large cracks may easily be repaired with the mortar supplied. Congratulations you have successfully built your own Woodfired ovens and will have many pleasurable experiences ahead!

Cracks: The type of cracking that you see in your oven is common and quite normal. With the extremely high temperatures that can be reached and the intensity of a natural heat source such as fire, your oven goes through a "settling in stage" where some expansion will take place. During this 'settling in stage' it is not uncommon for these expansion cracks to appear. These cracks are under no circumstance structural defects and will not affect the performance or durability of the oven. If the crack is quite significant i.e.: 5mm thickness then use your mortar to fix.